



G3™



User's Manual & Installation Guide

Canada Variant

Revision

7/October/2020



G3™

User's Manual & Installation Guide

**Canada Variant
Revision
7/October/2020**

Table of Contents

Welcome to Decatur Electronics	7
G3™ Features.....	8
About This Manual	9
1.0 Quick Start	11
2.0 Installation	12
2.1 Separating the Computer/Display Unit (Optional)	12
2.2 Mounting and Connecting the Computer/Display Unit.....	14
2.3 Mounting and Connecting the Antenna	17
2.4 Installation Check.....	20
2.5 VIP™ Installation (Optional).....	21
2.5.1 Connecting to the Radar	21
2.5.2 Connecting to the On-Board Diagnostic Port	21
2.5.3 VIP™ Activation	22
2.5.4 Configuring the VIP™	23
3.0 Operating the G3™	24
3.1 Power	24
3.2 Front and Rear Antenna	25
3.3 Stationary Both Mode.....	26
3.3.1 Using Directional Antennas	26
3.4 Moving Mode Opposite Direction	30
3.5 Moving Mode Same Direction	31
3.6 Fastest Mode.....	32
3.7 Locking a Speed	33
3.8 Range Setting	34
3.9 Stopwatch Operation Mode.....	35
4.0 Computer/Display Unit.....	37
4.1 Display Windows.....	38
4.2 Indicator Lights.....	39
5.0 Antenna	41
6.0 IR Remote.....	42
6.1 IR Remote Battery Replacement.....	49
7.0 Communication System Controls	51

- 8.0 Performance Tips.....51
 - 8.1 How Radar Works51
 - 8.2 Interference Sources and Remedies51
 - 8.2.1 Angular Interference (Cosine Effect)52
 - 8.2.2 Fan Interference53
 - 8.2.3 Batching53
 - 8.2.4 Electromagnetic Interference (EMI).....54
 - 8.2.5 Feedback Interference54
 - 8.2.6 Multi-Path Beam Cancellation.....54
 - 8.2.7 Patrol Harmonics54
 - 8.2.8 Radio Frequency Interference (RFI)55
 - 8.2.9 Shadowing55
 - 8.2.10 Motor Vehicle Ignition Interference).....56
- 9.0 Field Tests.....56
 - 9.1 Operator-Requested Self Test.....56
 - 9.2 Road Test59
- 10.0 Care, Cleaning, and Storage60
- 11.0 Specifications.....61
 - 11.1 Mechanical61
 - 11.2 Antenna61
 - 11.3 Environment.....61
 - 11.4 Power Consumption62
 - 11.5 Speed Range62
- 12.0 ISED Information.....63
- 13.0 Radiation Exposure Statement.....64
 - 13.1 Canadian Industry Certificates of Technical Acceptability.....65
- 14 Frequently Asked Questions (FAQ)67
- 15.0 Service68
 - 15.1 Warranty.....68
 - 15.2 Service Return Procedure69
- 16.0 How to Order Additional Products.....70

Appendix A - Communications Port71

Appendix B - Communications Port - Serial Protocols72

Appendix C - Menu Features73

User Notes:74



Welcome to Decatur Electronics, Inc.

Thank you for choosing the Decatur Electronics G3™ — A highly advanced traffic radar unit that will reward your department with years of dependable service. The G3™ design incorporates high performance and long range, with many leading features. We urge you to study this manual before using the G3™, so you can optimize the benefits of this sophisticated radar device. We believe you will be pleasantly surprised by the features and advantages.

The G3™ is small, dependable and features instant target acquisition. If you are as pleased with its performance as we think you will be, ask your Decatur sales representative about other Decatur products.

Traffic officers told us exactly what they wanted in a radar device - and we built it. Try any one of our products and see if you don't agree that it is the best-in-class!

—The Management and Staff at Decatur Electronics,
The Nation's Oldest Radar Company

G3™ Features

The G3™ is a modern traffic radar device offering many advanced capabilities. It includes 32-bit floating point digital signal processing (DSP), a versatile detachable computer/display unit, a Ka band directional antenna, and an easy-to-use Infrared (IR) remote control.

The G3™ provides instant target acquisition and speed lock as well as more precise tracking and speed measurement. If space in your motor vehicle is at a premium, you will appreciate the detachable computer/display unit. For more safety conscious installation options, you can separate the pieces and mount them wherever best meets your specific needs.

The IR remote controls all of the functions of the radar unit. The remote features convenient “eyes-off” raised buttons for use without taking your eyes off the road, white backlighting for low light use and fits comfortably in your hand, positioning all controls at your fingertips.

About This Manual

This manual contains valuable information to help you set up, use and maintain your G3™, so you can extend its life and keep it at peak performance. Please take a moment to read through it and keep it handy for future reference.

Note the following symbols in this manual:



Indicates a warning message about safety precautions. Please read it carefully.



Indicates a helpful tip or precaution to note.

Your G3™ radar unit includes selections from the following components:



**Detachable Computer/
Display Unit**



IR Hand Remote



Ka Band Directional Antenna



Various Connector Cables



Optional VIP



Various Mounting Brackets

1.0 Quick Start

Use the following instructions to quick start your G3™:

- With all cables and antennas attached, plug the cigar plug of the radar into a powered 12VDC cigarette lighter receptacle in the patrol motor vehicle.
- Press the PWR button on the front display to power up the radar unit. The radar will run through a brief self-test which includes illuminating all display segments.
- Press the FRONT or REAR button to select the antenna from which you want the radar to transmit. Press the same button when you wish to place the radar back into standby mode.
- Press and release the MODE button to quickly toggle between Moving Mode Opposite Direction and Moving Mode Same Direction. Press and hold the MODE button for two seconds to activate Stationary Mode.
- Press and hold the FAST button to select Faster Mode when you want to track the faster motor vehicles.
- In Moving Mode Same Direction setting, G3™ will automatically perform addition or subtraction relative to the patrol speed to properly calculate the target speeds.
- To lock a target speed, press the LOCK button (shown as a padlock on the hand remote). The target speed and its direction information will transfer to the LOCKED window and locked direction indicators. The radar will continue to process speeds and display them in the TARGET window.
- To clear a locked speed, press the LOCK button when an antenna is transmitting, and no target is present.

2.0 Installation

Use the following instructions to mount your G3™:

2.1 Separating the Computer/Display Unit (optional)

If the space in your motor vehicle is at a premium, you will appreciate the G3™ compact size and versatile components. You can separate and remotely mount the computer unit from the display unit. Common places to mount it are behind the dash, under the driver's seat, or on the console.

To separate the display from the computer unit, locate and remove the two display retaining screws (Green Arrows) using a 7/64" hex tool.



Figure 2.1a

Separating the computer/display unit.



Figure 2.1b

Using a hex tool, remove the retaining screws.

Pull the display from the computer and note the 9-pin connectors on each half of the unit. Screw two standoffs (included with the display separation kit) into the holes next to each connector on the display unit. These standoffs are used to attach the two pieces with the 9-pin connector cable.



Figure 2.1c

To connect the separated unit, first insert the standoffs to secure the cable connectors.

Then attach and secure the connectors with the thumbscrews on the sides of each cable connector.



Figure 2.1d

Secure the connecting cable by tightening the thumbscrews into the standoffs.

To return the unit to a one-piece configuration, remove the cables and standoffs, line up the 9-pin connectors, push the two pieces together and secure with the two retaining screws.

2.2 Mounting and Connecting the Computer/Display Unit



WARNINGS

- Do not place the G3™ components in locations that will obscure the driver's view of the road.
- Double-check each component to ensure it is securely mounted. In an accident, a loose component could strike an occupant of the motor vehicle.
- Do not place the G3™ computer, antennas, cables, or brackets in your motor vehicle's air bag deployment zones. Refer to your motor vehicle's owner's manual or call the motor vehicle manufacturer if you are unsure where the air bag deployment zones are.

You can mount the computer/display unit behind and to the side of the steering wheel or on the dashboard. The computer unit easily withstands and remains accurate in temperature extremes. Dash mounting the unit promotes safety; you can read the display without taking your eyes off the road.

To mount the unit, use the Velcro™ fastening material or the mounting bracket. Before applying the Velcro™, use a clean cloth to remove any foreign material from the dashboard and bracket face. Position the Velcro™ lightly on the computer/display unit and mounting surface.

After the unit is in the correct position, press it firmly to affix it to the surface. For the bracket mount, simply place and tighten the screws on the mounting bracket into the holes in the unit. Then adhere the suction cups to a clean glass surface. For maximum adhesion, moisten the suction cups before affixing them to the surface.

There are four locations where cables connect to the rear panel of the computer unit. Two are quick-disconnect Ethernet connectors for the antennas, a third is a nine pin DB-9 connector and the last is a quick disconnect power connector.

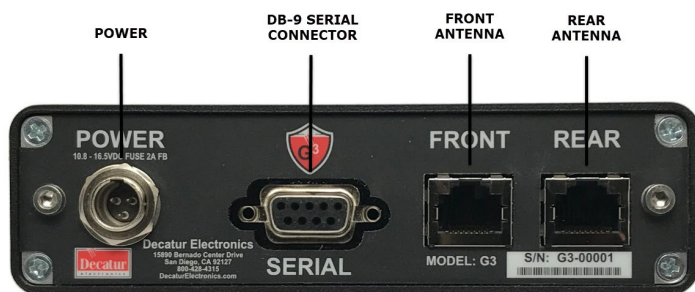

Figure 2.2a

The antenna quick-disconnect connectors plug into the computer unit in the above locations.

Power Cable



WARNINGS

- Be sure to plug the power connector into the computer unit first before plugging the power plug into the auxiliary power source. If the power source is on, it may damage the unit.

The power cable has a 12-volt power plug (cigar plug) on one end. Make sure the plug fits securely in the motor vehicle's auxiliary power (cigarette lighter) receptacle. Attached the other end to the power connector by aligning the cable so the black dot is up and press until it clicks. To remove press the black dot and pull.



Figure 2.2b

The cigar plug for the auxiliary power receptacle.

Antenna connector

The antennas are connected to the computer unit with a CAT 7 shielded Ethernet cable. Either end of the cable can be used to connect to the antenna or computer unit.

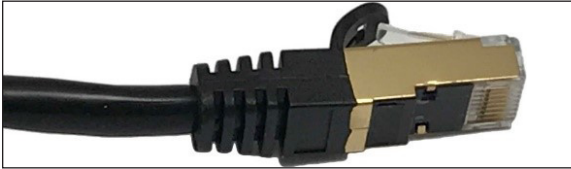

Figure 2.2c

Cable connector that plugs into the antenna or computer unit

To attach an antenna cable:

1. Align the antenna cable Ethernet connector with the receptacle.
2. Push the connector into the receptacle until you hear a click.
3. To remove the connector, press down on the top cable plug latch and pull apart.



Figure 2.2d

Align the latch on the top of the Ethernet plug with the notch on the computer Ethernet receptacle.



WARNINGS

- Only use factory authorized antenna cables. Substitution of non-authorized cables can affect the operation of the G3™

Serial connector

On the back of the computer unit there is a female DB-9 connector marked "SERIAL" that allows you to connect the G3™ to other devices (i.e . display signs, in-car video, PCs, or the VIP (Vehicle Interface Portal) .

2.3 Mounting and Connecting the Antenna

A variety of brackets are available. To attach the antennas to the standard brackets, align the threaded mounting hole on the antenna with the threaded post of the front antenna bracket and on the rear antenna bracket the threaded knob with the slot on the L-brace. Then screw the post or knob into the threaded mounting hole.



Figure 2.3a

A front mount antenna using the P773-237 bracket



Figure 2.3b

A rear mount antenna using the S758-34-0 bracket

Front Antenna Mounting

When mounting the front antenna bracket to the windshield use the following bullet points to help in determining the proper location.

- Make sure that you **Do Not** mount the antenna in the deployment path of the air bag or where it will obstruct the driver's vision.
- Choose a location so that the antenna will be completely below the tinted area of the windshield.
- Test the antenna location for good performance and for any fan interference.

Once the considerations listed above have been observed, make sure that the windshield glass is properly cleaned and prepared. To remove the suction cup bracket, first release the seal by pulling up on the tab on the rubber suction cup.

Antenna Alignment

After you affix the bracket to the windshield, adjust the position of the antenna. **SIGNIFICANT DEVIATION FROM A PARALLEL ORIENTATION CAN AFFECT THE RADAR'S READING DUE TO THE COSINE EFFECT.** (See Figure 2.3c)

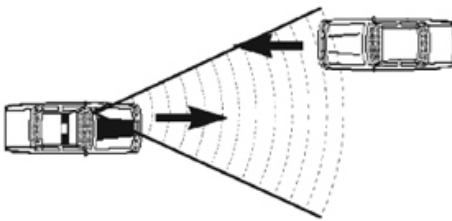

Figure 2.3c Correct Orientation

The antenna is parallel to the target motor vehicle's direction

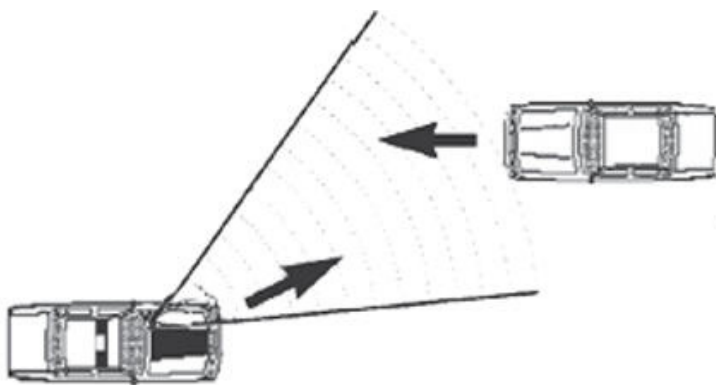

Figure 2.3d Incorrect Orientation

The antenna & target motor vehicle's direction are not parallel

Rear Antenna Mounting

Mount the rear-facing antenna near the center brake light where it is not obstructing a clear view of traffic. The bracket is easily affixed to the rear deck using the Velcro™ strips supplied with the bracket. Follow the same orientation instructions as for the front antenna.

- • **Use only the mounting hardware provided.** Damage to the antenna housing can occur if you use incorrect fasteners.
- Do not modify the brackets. Most brackets incorporate a ground isolator that prevents the metal housing of the antenna from coming into contact with the frame of the patrol motor vehicle. Removal of the isolator can cause interference to be easily picked up diminishing performance.
- To reduce interference, position the antenna away from the patrol motor vehicle's display, fans, engine, laptops and the G3™ computer unit.
- When removing other optional brackets that have suction cups, use the tabs on the suction cups to break the vacuum seal.

After you have mounted the antenna, plug one cable end into the antenna and the other end into the antenna receptacle on the computer/display unit.

If you are using only one antenna, you must connect it to the FRONT antenna receptacle.

2.4 Installation Check

After you install the components, for safety, double-check to ensure all components are secure. Then check for potential interference from sources such as the air conditioner/heater fan.

1. With all other motor vehicle accessories off, turn on the heater/air conditioner fan.
2. Power up the radar by pressing the PWR button on the front display and select the front antenna by pressing the FRONT button.
3. Cycle through the fan's low to high settings.
4. If the unit displays a reading, reposition the antenna to eliminate it. Often, the far-left corner of the front windshield is an interference-free zone where you can place an antenna.
5. Repeat this process for the rear antenna.

2.5 VIP Installation (Optional)

If your G3™ has come with the optional Vehicle Interface Portal™ (VIP™) then use the following installation instructions.



WARNING

- Before connecting the VIP™, ensure all devices, including the motor vehicle and radar are powered off.

2.5.1 Connecting to the Radar

Connect the VIP's™ communications cable to the SERIAL port located on the back panel of the radar unit.

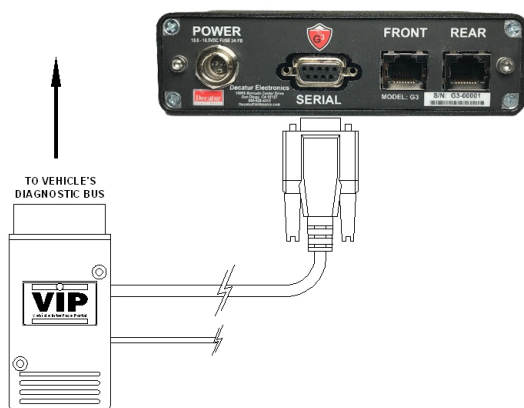

Figure 2.5.1a
VIP connection to Radar

2.5.2 Connecting to the On-Board Diagnostic Port (OBD II)

Connect the VIP™ to the motor vehicle's On-Board Diagnostics port. (Refer to your owner's manual for the location of your motor vehicle's OBD-II port.)

In some motor vehicles the clearance between where the diagnostics port is located and the bottom of the dash is very close and can cause the port and VIP™ to be bumped by the officer's leg when getting into the motor vehicle. In those cases, Decatur offers a two-foot right angle extension cable (S769-15) to allow the VIP™ to be relocated away from the port so as not to be damaged. Contact your Decatur Sales Representative for more information on this product.

2.5.3 VIP™ Activation

Before activating the VIP™ it is recommended that you read Section 3 on Operating the G3™.

Note: The motor vehicle must be running, simply having the key turned to auxiliary is not enough to fully activate the VIP™.

Make sure the LED light on the VIP™ is constantly on.



The VIP™ does not have to be plugged into the G3™ for you to note the LED status.

- It may take up to 60 seconds for the VIP™ to start communicating with certain motor vehicles, although most only take a few seconds.
- If the LED is flashing, there are errors in the data being sent from the motor vehicle.
- Do not expose the VIP™ to excessive moisture or submerge the VIP™.
- If the LED is mostly off but flickers only occasionally there is an issue with the power being supplied to the VIP™. The VIP™ is in hibernation mode to conserve the motor vehicle's battery.

If the LED is on and the VIP™ is connected to a radar unit, then when the radar is turned on and it runs through its diagnostics routine it will show the message "VIP" as the last message on power up.

Once the power-up routine has run correctly and the VIP™ message has been displayed, the next step is to make sure the G3™ computer is configured properly. To do this have the motor vehicle running but stopped. With the VIP™ properly installed try to put the radar into moving mode. The VIP™ should note that the motor vehicle is stopped and automatically switch the radar to stationary mode.



- If your radar does not automatically switch to stationary mode when stopped, please check the menu feature setup on the radar and make sure the VIP™ mode has been set to AUTO.

The next step will walk you through setting up the VIP™ if it is not being recognized by the radar. You can also refer to the menu feature set up in the radar's operator manual.

2.5.4 Configuring the VIP™

To get the G3™ to recognize that the VIP™ has been connected it may be necessary to go into the radar's menu feature and select the VIP™.

1. With the radar turned on and all power-up routines having been ran, press the MENU button on the IR remote.
2. Next, press the OPTION button several times until VIP™ is displayed in the locked/fast window.
3. Press the UP arrow (front antenna) or down arrow (rear antenna) button and make sure the word AUTO is showing in the patrol display.
4. Press the MENU button again to exit the menu and save the setting.

The VIP™ is now be configured to the radar.

2.5.5 How The VIP™ Helps Eliminates Shadowing

In Moving mode, the radar processes two speeds - patrol and target. The stronger of the two, the patrol speed, is created when the radar beam reflects from passing stationary objects, such as the pavement or terrain the motor vehicle is traveling on. However, in rare cases, some situations cause return signals to be larger than the reflection from the ground such as when the patrol motor vehicle is rapidly overtaking a slow-moving 18-wheeler. The radar may use the large return signal generated by the semi's trailer ignoring the ground return.

This results in an artificially low Patrol speed. The computer would then subtract this artificially low speed from the closing speed and assign a higher speed to the target. The VIP™ eliminates this problem by monitoring the speed information being sent from the OBD II diagnostics port and forces the radar to use the correct ground return.

Automatic Moving/Stationary Mode Switching

When activated the VIP™ will automatically switch between moving and stationary modes based on the movement of the patrol motor vehicle. The G3™ will automatically switch to stationary mode any time the patrol motor vehicle comes to a stop. Once the patrol motor vehicle starts moving again the G3™ will switch the radar back to moving mode.

3.0 Operating the G3™

After you test and confirm that the unit is properly installed, it is ready for use.

3.1 Power

The PWR button on the display turns the G3™ on and off whereas the PWR button on the IR remote only turns the G3™ off. After you press the PWR button, the display illuminates with a segment check and internal circuitry verification. If the power-up checks pass, the radar will set itself to the last operational mode prior to being powdered off.

If the power-up checks fail, SYSTEM ERR will display in the windows and the unit will not respond to any control except the PWR button to power down. Turn the unit off then back on. If the error message persists, remove the unit from service and contact your Decatur Sales Representative.



- When the G3™ is powered down, it stores the current settings. These settings are restored the next time you power up the unit.

3.2 Front and Rear Antenna

At power up, the G3™ antennas are in standby mode. (Standby mode is when the antenna is not transmitting.) If no antenna is connected to the unit, the FRONT and REAR lights cycle on and off and NO ANT displays in the locked and patrol windows.



Figure 3.2a

If no antenna is connected, NO ANT Displays

The radar unit will not begin transmitting until you press an antenna button. The antenna buttons, up arrow (FRONT) and down arrow (REAR), on the IR remote activate and deactivate the antennas. The FRONT or REAR icons will illuminate when that antenna is transmitting.



Figure 3.2b

The FRONT or REAR light illuminates when that antenna is transmitting.

To discontinue transmitting (to place the radar back into standby mode), press the same antenna button.

The G3™ has five main operating modes: Stationary Both, Stationary Approach Only, Stationary Recede Only, Moving Mode Opposite Direction, and Moving Mode Same Direction.

3.3 Stationary Both Mode

You can use Stationary Both Mode to monitor traffic that is moving toward or away from the parked patrol motor vehicle.

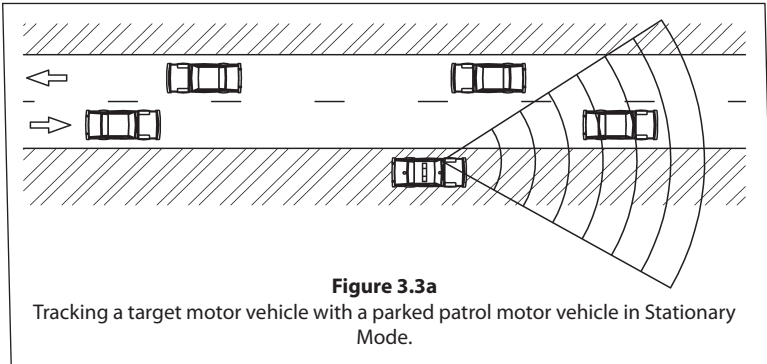

3.3.1 Using Directional Antennas

When using the directional antenna that come standard with the G3™, you can use Stationary Approach Only or Stationary Recede Only Modes to isolate traffic in a one direction only.

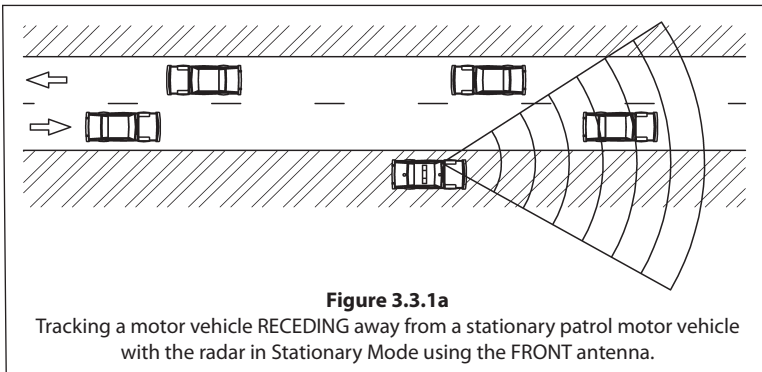

There are three selections for stationary mode:

Stationary All

Tracks all motor vehicles approaching or receding away from the patrol motor vehicle.

Stationary Approach Only

Only tracks motor vehicles approaching the patrol motor vehicle.

Stationary Recede Only

Only tracks motor vehicles receding away from the patrol motor vehicle.

While in stationary mode, the G3™ will display different direction information depending on whether the radar is in Approach or Recede mode and whether an antenna is activated. If an antenna is activated, arrows to the right of the target and fast windows will illuminate to communicate the direction the target motor vehicle is traveling. If neither antenna is activated (transmitting), then G3™ will display direction information in the patrol window as "ALL" for All targets, "APP" for Approach only or "REC" for Receding only targets.

To select a Stationary Mode of operation, press and hold the MODE button for two seconds.

After the "Stationary All" mode has been selected, briefly press and release the MODE button a second time to select the "Stationary Approach Only" mode. Pressing and releasing the MODE button a third time will select the "Stationary Recede Only" mode. Pressing and releasing the MODE button a fourth time will cycle to the moving opposite mode of operation.

When the radar is in HOLD mode (No antenna transmitting) the figures below show the three stationary modes that the radar will cycle through. (Patrol window will display "ALL", "APP" or "REC" for ALL direction, APProach only or RECede only)

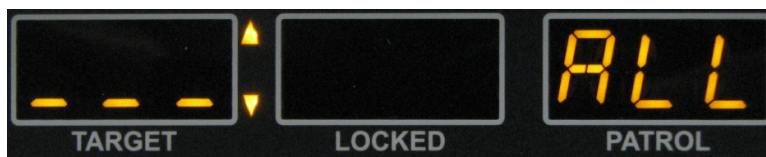

Figure 3.3.1b

Stationary track ALL targets (No antenna is selected)



Figure 3.3.1c
Stationary track Approach targets (No antenna is selected)

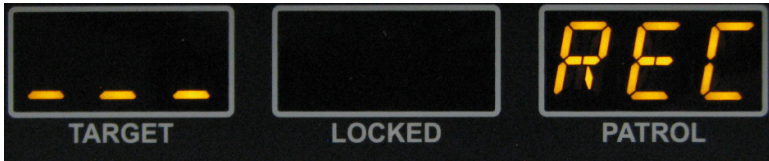

Figure 3.3.1d
Stationary track Recede targets (No antenna is selected)

When an antenna is transmitting, the radar will switch to only displaying the up or down arrow corresponding to the target direction of travel.



Figure 3.3.1e
Both up and down Arrows display in Stationary All Mode when front or rear antenna is selected.

When the radar is toggled into the “Stationary Approach Only” mode, the up pointing or down pointing arrow to the right of the TARGET window will illuminate. (When using the FRONT antenna, targets approaching the patrol will be represented by the arrow pointing down. An arrow will be pointing up when the REAR antenna is selected and a target approaching the rear antenna.

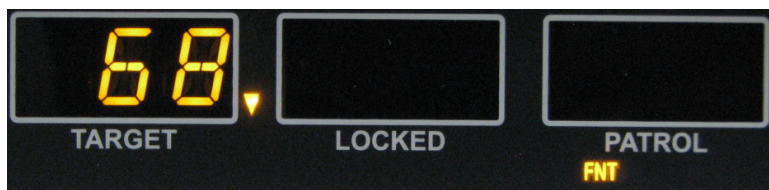

Figure 3.3.1f

While the FRONT antenna is selected, the down pointing arrow is illuminated while tracking an approaching motor vehicle.

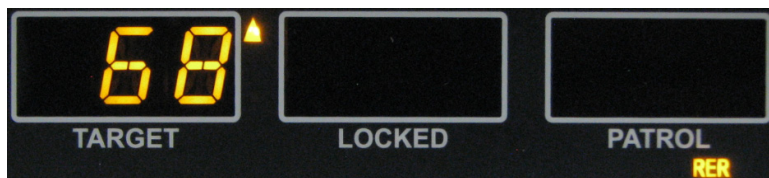

Figure 3.3.1g

While the REAR antenna is selected, the up pointing arrow is illuminated while tracking an approaching motor vehicle.

When the radar is toggled into the “Stationary Recede Only” mode, the down pointing or up pointing arrow to the right of the TARGET window will illuminate. (When using the FRONT antenna, targets receding from the patrol will be represented by the arrow pointing up. An arrow will be pointing down when the REAR antenna is selected.)

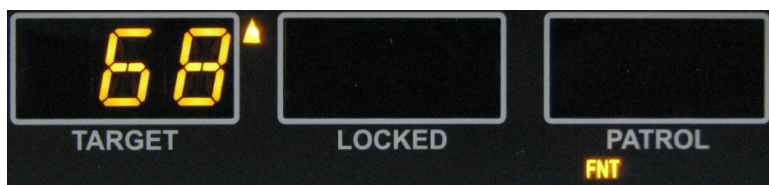

Figure 3.3.1h

While the FRONT antenna is selected, the up pointing arrow is illuminated while tracking a receding motor vehicle.

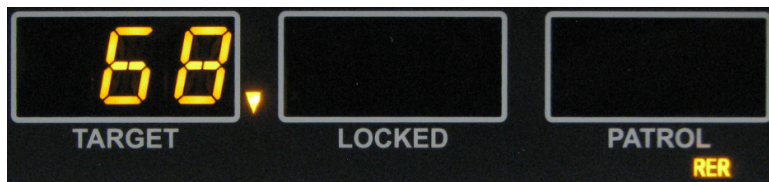

Figure 3.3.1i

While the REAR antenna is selected, the down pointing arrow is illuminated while tracking a receding motor vehicle.

**WARNING**

- Make sure the antenna facing forward is connected into the "FRONT" antenna port. If using dual antennas, the antenna facing the rear must be connected into the "REAR" antenna port.

3.4 Moving Mode Opposite Direction

Use the G3™ in the Moving Mode Opposite Direction setting to display the speed of a target moving in the opposite direction from the moving patrol motor vehicle. These targets will be moving towards the patrol (using the front antenna) or away from the patrol (using the rear antenna).

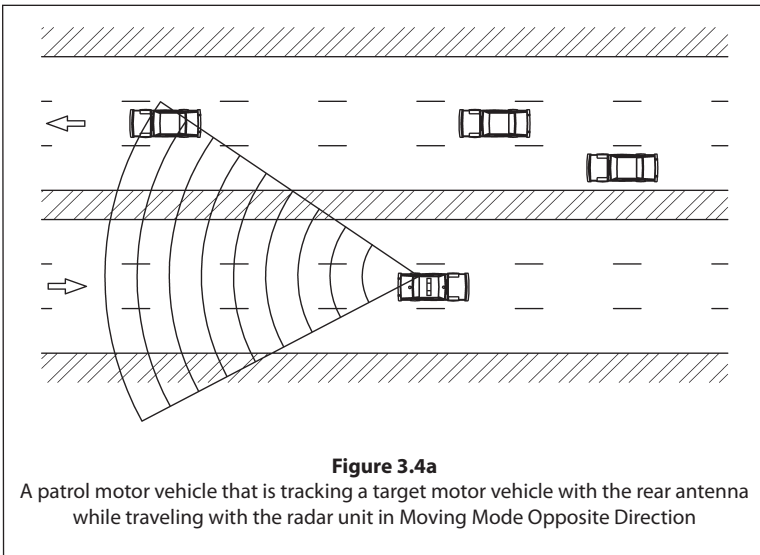

To select Moving Mode Opposite Direction, press the MODE button until the OPP icon is illuminated.

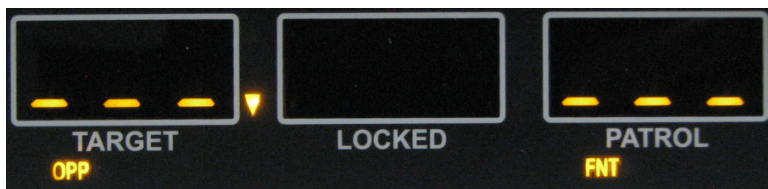

Figure 3.4b

While the FRONT antenna is selected, the down pointing arrow is illuminated while tracking an approaching motor vehicle in moving opposite mode.

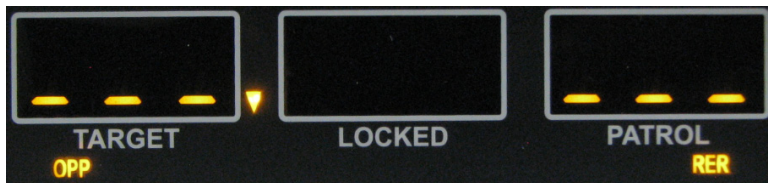

Figure 3.4c

While the REAR antenna is selected, the down pointing arrow is illuminated while tracking a receding motor vehicle in moving opposite mode.

In moving opposite mode, the G3™ simultaneously processes and displays the patrol and target motor vehicle speeds. Detected target speeds will appear in the TARGET window. When no targets are present, the TARGET window will show three dashes. Patrol speeds will display in the PATROL window while the patrol motor vehicle is moving.

3.5 Moving Mode Same Direction

To display the speed of targets traveling the same direction as the patrol motor vehicle, use the Moving Mode Same Direction setting.

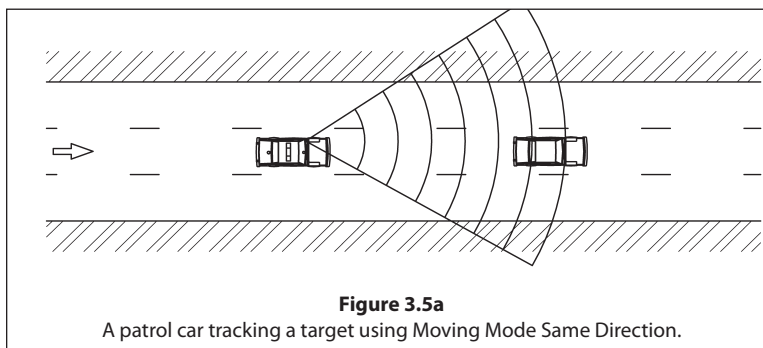

Figure 3.5a

A patrol car tracking a target using Moving Mode Same Direction.

To select this mode, press and release the MODE button until the

SAME icon is illuminated.

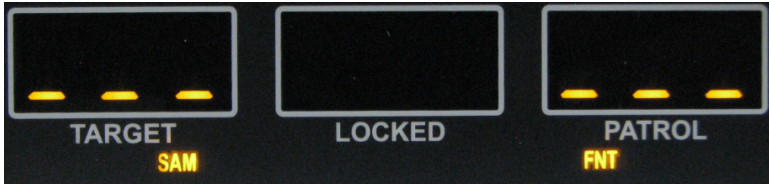

Figure 3.5b

While the FRONT antenna is selected, the down or up pointing arrow will be illuminated depending on whether the target motor vehicle is approaching or receding the patrol motor vehicle in same direction mode.

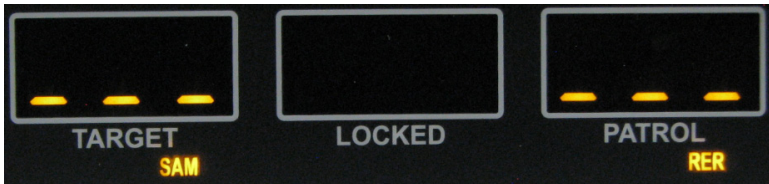

Figure 3.5c

While the REAR antenna is selected, the down or up pointing arrow will be illuminated depending on whether the target motor vehicle is receding or approaching the patrol motor vehicle in same direction mode.

The G3™ uses directional antennas so there is no need to manually select faster or slower modes in same direction. The G3™ does this automatically for you.

3.6 Fastest Mode

The FAST button activates the Fastest Mode, modifying the operation of the Stationary, Moving Mode Opposite Direction and Same Direction modes.

The Fast light illuminates when you press the FAST button on the IR remote. When activated, the radar will search and find the fastest target and display it in the fast/lock window. For example, in Figure 3.6a, the 85-km/h motor vehicle is the target motor vehicle that will be displayed in the fast/lock window.

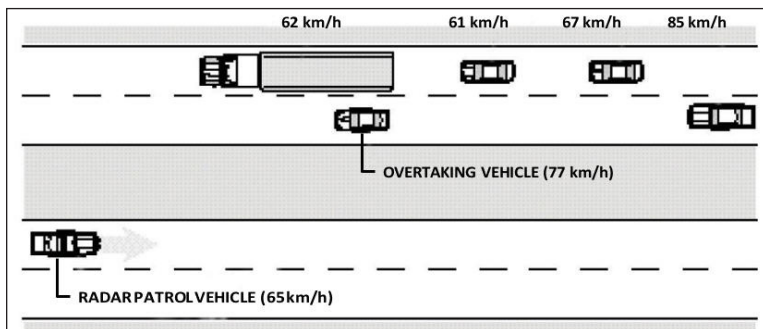

Figure 3.6a
Evaluating multiple targets in Faster Mode.

3.7 Locking a Speed

Pressing the LOCK button transfers the target speed and direction information currently displayed in the TARGET window to the LOCKED window. After locking the speed, the radar unit continues to process speeds and display target speeds in the TARGET window. This lets you continue to track the history of the target.

To clear a locked speed do one of the following:

- Press the LOCK button when an antenna is transmitting, and no target is present.
- Change the operating mode.
- Turn the antenna off and on.

3.8 Range Setting

You can adjust the range (sensitivity) of the G3™ in each of the three operating modes independently:

- Moving Opposite Mode
- Moving Same Lane Mode
- Stationary Modes

The G3™ can track the speed of targets that exceed 914 meters when the unit is set at maximum range. The range setting is available in the main menu location. To change the range setting for a mode, press the MENU button on the IR remote. Radar will display:



Figure 3.8a

The G3™ front display showing range or sensitivity setting.

Press the FRONT antenna (+) or REAR antenna (-) to increase or decrease the range setting. The range value on the far right PATROL display will change. The maximum range setting is 5 while the minimum is 1. Initially, you will want to start with minimum range, then increase the range setting until you obtain a desired performance level. For example, an operator would use reduced range when operating within a city environment. Pressing the MENU button again will exit the main menu and save the range setting. The range setting for each operating mode will be permanently saved when the radar is powered off.

3.9 Stopwatch Operation Mode

Calculate target speeds without transmitting radar signals by using the stopwatch mode. The stopwatch mode relies on the time/distance formula to calculate target speeds by measuring the amount of time a motor vehicle takes to travel a known distance.

$$\text{Speed} = \text{Distance} / \text{Time}$$

To place the radar into stopwatch mode, first ensure that no antenna is currently selected, then press and hold the OPTN button for two seconds. The center "locked" window should display "STW" to indicate you have activated the stopwatch function.



Figure 3.9

The Locked window will display "STW" whenever the G3™ is operating in the Stopwatch Mode

The three numeric windows display time, distance, and speed.

TARGET WINDOW	Calculated Speed in km/h
LOCKED WINDOW	Distance in Meters
PATROL WINDOW	Time in Tenths of Seconds

Example:

Distance Set to:	402 Meters
Time Measured:	150 (15 .0 Seconds)
Calculated Speed:	96 km/h

To make use of the stopwatch mode, you need a road surface that is marked with known distance intervals, or you will need to independently make a measurement between two visible points on the road in which you can time motor vehicles passing between those points (for example a bridge underpass and a road sign) with some precise distance measuring equipment.

Once you have an established measurement area, use the FRONT ANTENNA BUTTON or the REAR ANTENNA BUTTON to increase or decrease the distance of the measurement area in meters. The LOCKED window will show the distance when adjusting but will revert to displaying STW after a few seconds of no distance change.

When the correct distance is set, you can time motor vehicles as they cross between the markers in your measurement area. Use the LOCK button to start and stop the timer. The time will be counted and displayed in the PATRTOL window. Each sequential number represents a tenth of a second.

After you have started and stopped the timer, a calculated speed will be displayed in the TARGET window. The speed shown will be in km/h.

The accuracy of the stopwatch mode will be limited by the precision in which the distance measurement was made and the precision in which the timer start and stop was activated. In general, to increase the accuracy of the measurement, use a longer measurement area.

Press the MODE button to exit the Stopwatch mode.



- If MPH units have been selected in the set up menu, the distance units will be in yards and the speed shown will be in MPH.

4.0 Computer/Display Unit

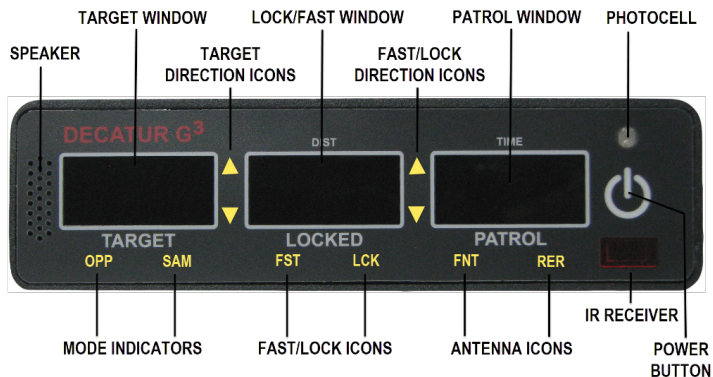

Figure 4a
The G3™ front display.

The G3™ display contains a photocell that automatically dims the display at night for less glare and makes the display brighter in daylight conditions, so you can easily read the display.



Figure 4b
The G3™ rear interface

4.1 Display Windows

TARGET: Displays target speeds. Is blank when no target is present.

LOCKED: When you press the LOCK button, the LOCKED window holds and displays the target speed that was in the TARGET window.

PATROL: Displays the patrol speed. The window is blank when the radar unit is in Stationary Mode or when the motor vehicle is traveling below the minimum patrol speed.

ERROR DISPLAY: When an error occurs, one of the following appears in the display windows:

LOW VOLT: Low voltage



Figure 4.1a

The G3™ front display showing LOW VOLT error display.

RFI: Radio Frequency Interference



Figure 4.1b

The G3™ front display showing RFI error display.

SYSTEM ERR: System Failure



Figure 4.1c

The G3™ front display showing SYSTEM error display

4.2 Indicator Lights

FAST: The FST icon light is used to indicate when the radar is in faster or fastest mode. Pressing the FASTER button again will return the unit to normal operation and the FASTER light will shut off.



Figure 4.2.1a
The Fast light

ANT FRONT and REAR: Indicates which antenna is transmitting. In standby mode (not transmitting), neither light is on. LED icon FNT identifies the FRONT ant while LED icon RER identifies the REAR ant.



Figure 4.2.1b
Antenna lights

LCK: Indicates when a target speed has been locked into the locked window.



Figure 4.2.1c
Lock indicator

OPP and SAM: Indicates what moving mode the radar is in. In opposite moving mode, OPP is illuminated while in same direction mode, SAM is illuminated.



Figure 4.2.1d
OPP and SAME indicator lights

TARGET DIRECTION INDICATORS: Indicates what direction of travel the target is moving relative to the patrol motor vehicle. The active FRONT or REAR antenna will determine which up or down pointing arrow is illuminated.



Figure 4.2.1e
TARGET Direction indicator lights

LOCKED/FAST DIRECTION INDICATORS: Depending on the current radar state, these indicators will report:

- (1) **In fastest operation:** Indicates what direction of travel the fastest target is moving relative to the patrol motor vehicle. The active FRONT or REAR antenna will determine which up or down pointing arrow is illuminated.
- (2) **When a speed has been locked:** Indicates what direction the target was traveling when locked.



Figure 4.2.1f
LOCKED/FAST Direction indicator lights

5.0 Antenna

The G3™ Ka-band Directional antennas are incredibly strong, yet compact and lightweight.



Figure 5a

Front view of the G3™ Ka directional antenna.



Figure 5b

Rear view of the G3™ Ka directional antenna

6.0 IR Remote

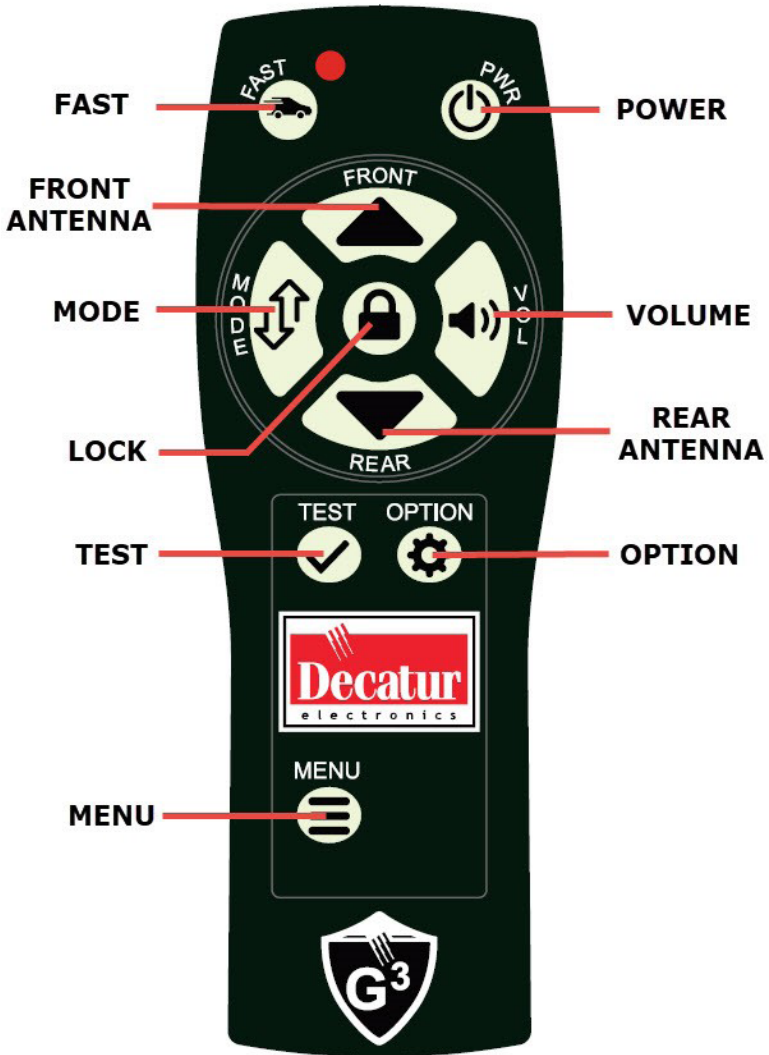

Figure 6a
The S795-41-0 IR remote-control unit.



- The IR remote control needs to be aimed in the general direction of the radar display to properly receive the IR signals. To help increase IR signal levels, the IR remote has two IR emitters. One emitter is located on the top near the FAST button and the other one is located on the front face.

6.1 Control Buttons

POWER (PWR): powers the G3™ off. The G3™ will save all user settings on power down.

OPTION: Pressing the OPTION cycles through a list of changeable settings in the primary menu. See Appendix C for the complete list.

TEST: Pressing and releasing the TEST button starts an extensive self-test of the radar unit's circuitry. During self-test, the system will not power down until the test is complete. If the self-test fails, the SYSTEM ERR message will appear in the radar windows. For more information on tests, see Section 9: Field Tests.

VOLUME: The 8-step volume control regulates the Doppler audio and system status tone (beep) volume. Every press of the button increments the positive (+) side of the volume. When the maximum volume level has been reached, the next button press will reset the level back to minimum.

With every press of the Volume button, the G3™ will display the current volume level in the locked window. A letter "V" followed by the volume level is displayed in the window momentarily.



Figure 6.1a

The G3™ front display showing radar tracking a target at 50 km/h and showing a volume level of 5 during a volume button press.

FAST (FAST): Controls the Faster/Fastest Mode feature when you are evaluating multiple targets.

MODE: Switches between the three operating modes: Stationary Mode, Moving Mode Opposite Direction, and Moving Mode Same Direction.

LOCK: Transfers the target speed and direction indicators in the TARGET window to the LOCKED window. After locking the speed, the system continues to process and display target speeds in the TARGET window, so you can continue to track the history of the target speed. To clear a locked speed, press the lock button on a bank target speed (while an antenna is active), change modes or deactivate and then re-activate an antenna. If you have the Patrol Speed Lock, Recall, and Blanking option, pressing the LOCK button locks both the target and patrol speed.

ANTENNA FRONT and REAR: Activates and deactivates the front and rear antenna. An antenna must be activated to track a target speed.

MENU: Activates the primary menu on the G3™. Used in conjunction with the OPTION button to cycle through the available options that are changeable. Pressing the MENU button again will exit the primary menu.

MENU ITEMS:**(a) SENS (RANGE)**

Sets the maximum range for the radar. Settings are 1 (min) through 5 (max). Press the Front antenna button to increment through the settings or press the Rear antenna button to decrement through the settings.

**Figure 6.1b**

The G3™ front display showing radar menu range or sensitivity display.

(b) SQUELCH

Sets squelch mode. Selects the type of Doppler audio you hear. In squelch mode, the sound heard is only from the Doppler tone for the currently displayed target. In unsquelched mode, the unit passes all Doppler tones, interference and noise received from the antenna. You typically use unsquelched audio when you listen for interference. Press the front or rear antenna button to toggle between off and on.

**Figure 6.1c**

The G3™ front display showing menu SQUELCH display.

(c) DIM

Allows manual or automatic dimming of LED display. If MENU display setting reads AUTO then the display will automatically dim or brighten as necessary to maintain good readability. To manually dim the display, press the front or rear antenna to select a brightness level. There are 8 levels of brightness (1 – 8) where 8 is the brightest setting.

**Figure 6.1d**

The G3™ front display showing menu DIM (AUTO and MANUAL setting of 1)

(d) BEEP

Turns on or off the beep. Press the front or rear antenna button to toggle between off and on.

**Figure 6.1e**

The G3™ front display showing menu BEEP option selection display.

(e) COM serial setting

Selects serial output protocol. Press the front or rear antenna button to toggle between the selections. (See appendix A for full list of communication formats)

**Figure 6.1f**

The G3™ front display showing serial communication protocol selection display.

(f) HARMONIC setting

Selects harmonic display in the target window. Target window will display “_H_” during a patrol harmonic event (display will normally be blank if this setting is OFF). Press the front or rear antenna button to toggle between OFF (default) and ON.

**Figure 6.1g**

The G3™ front display showing harmonic display option.

(g) VIP – AUTO or MANUAL setting

AUTO for Automatic switching between Stationary and Moving mode. Man for Manual switching of modes.

**Figure 6.1h**

The G3™ front display showing menu selection of VIP MANUAL or AUTOMATIC mode switching.

(h) CITY HWY MODE setting

Set for HWY (HIGHWAY) use to help reduce shadowing, Set for CTY (CITY) use to help prevent combining. Set to ALL (default) for best performance in both environments. Use the antenna front and rear buttons to cycle through the three options.

**Figure 6.1i**

The G3™ front display showing menu selection of CITY/HIGHWAY use.

PATROL SPEED LOCK, RECALL and BLANKING

This option locks the patrol speed at the time you lock the target speed.

1. In either moving mode, press the LOCK button to lock both the target or patrol speeds.
2. Turn the antenna off. The locked patrol speed will appear in the PATROL window.
3. To blank the patrol speed, press the OPTN button. Then press the OPTN button again to recall it.
4. To permanently remove the locked patrol speed, reactivate the antenna by turning it on.

6.1 IR Remote Battery Replacement

To add or replace batteries for the remote control, turn the remote over and locate the battery cover. Press the small detent as shown below and push forward. Slide the cover off to expose the battery compartment.

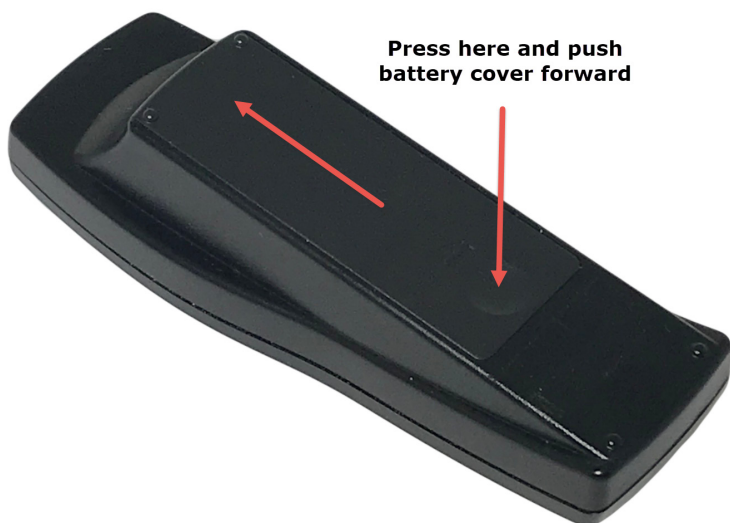

Always use high quality alkaline AAA batteries to power the remote. Install batteries as shown below. Replace battery cover before placing remote back into service.



- If the G3 is used in cold weather, the alkaline batteries may not deliver enough current to drive the IR emitter properly. In this case, use a high-quality Lithium AAA rated for low temperature. A recommended battery is: Energizer L92 Ultimate Lithium

ENERGIZER L92

Ultimate Lithium



7.0 Communication System Controls

You can configure the G3™ through the serial communications (COM) port on the rear panel to communicate with PCs, speed signs, and in-car video systems, such as the Decatur Electronics Responder 1000™ in-car video system. The communications cable does not come with your order and can be purchased separately from Decatur Electronics. See Appendix A for the more details on the serial communications port configuration.

8.0 Performance Tips

Understanding potential radar interference sources and what to do when they occurs can greatly improve your results.

8.1 How Radar Works

Determining a motor vehicle's speed begins with the radar antenna transmitting and directing a beam of microwave energy (radio waves) at an approaching (or receding) target motor vehicle. When energy from this beam strikes a moving motor vehicle, a small amount of the beam is reflected back to the antenna.

The reflected signal frequency shifts by an amount proportional to the speed of the target motor vehicle. This is known as the Doppler Effect. The radar device then determines the target motor vehicle speed from the difference in frequency between the reflected and transmitted signal.

8.2 Interference Sources and Remedies

When properly installed and operated, Doppler radar technology is extremely accurate and reliable. However, variations in the environment can cause situations and circumstances, which can cause spurious (erratic and unusually low or high) speeds to display. Signs that a speed is spurious can include the following characteristics:

- A reading appears when no target motor vehicle is in the operational range of the antenna.
- A target motor vehicle entering the operational range overrides the interference signal, causing the display speed to change suddenly to the motor vehicle's speed.

- The Doppler tone is corrupted with noise.
- Speeds are irregular and do not provide valid tracking history.
- Erroneous speeds appear to track with the engine speeds.

8.2.1 Angular Interference (Cosine Effect)

When operating in the Stationary Mode, the cosine effect causes the radar to display a speed, which is lower than the actual motor vehicle speed. This condition exists when the target motor vehicle's path is not parallel to the antenna, including conditions such as the motor vehicle traveling on a curve or a hill.

As the angle between the beam of the antenna and the target motor vehicle increases, the displayed speed decreases. Ideally, an angle of zero (0) degrees is preferable, because the displayed speed is the actual target motor vehicle speed. However, in all uses of police radar, the radar device is always at a slight angle to the target motor vehicle to avoid collisions.

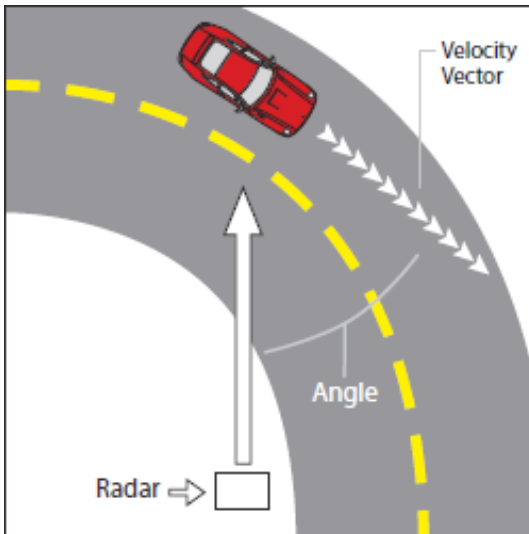

Figure 8.2.1a

An angle between the antenna and the target motor vehicle causes the cosine effect.

The following table shows the effect that an increasing angle has on a displayed speed.

Actual Speed	Horizontal Angle Degrees										
	0°	1°	3°	5°	10°	15°	20°	30°	45°	60°	90°
	Displayed speed:										
50 km/h	50	49	49	49	49	48	46	43	35	25	0
65 km/h	65	64	64	64	64	62	61	56	45	32	0
80 km/h	80	79	79	79	79	77	74	69	56	40	0
90 km/h	90	89	89	89	88	86	84	77	63	45	0
100 km/h	100	99	99	99	98	96	93	86	70	50	0
110 km/h	110	109	109	109	108	106	103	95	77	55	0

Table 8.2.1b

Actual and displayed speeds at different antenna-to-target angles.

Small angles (less than 10°) have little effect on displayed speeds. As the angle increases, the displayed speed decreases. At 90°, the displayed target speed is 0 km/h.

8.2.2 Fan Interference

Fan interference is the most common form of interference that you are likely to experience. It is caused when the radar measures the speed of the motor vehicle blower fan. Changing the fan speed causes a proportional change in the display speed. To correct this, relocate the radar antenna so it does not display spurious speeds or turn off the fan motor.



- Fan interference can be problematic in Same Direction Mode and should be checked carefully.

8.2.3 Batching

In past years, some radar devices occasionally could not correctly process speeds when the patrol motor vehicle was accelerating or decelerating at unusually high rates. In these cases, radar devices used an earlier speed to calculate the patrol speed, rather than the current speed. The radar will display an incorrect target speed, because it is using an incorrect patrol speed. With the DSP algorithms the G3™ uses, this error will not occur.

8.2.4 Electromagnetic Interference (EMI)

Operating electric motors can produce EMI. With the DSP algorithms the G3™ uses, this error will not occur.

8.2.5 Feedback Interference

When radar is directed at computer screens, streetlights, and other electronic devices, it can display spurious speeds. To correct this type of interference, relocate the radar antenna.

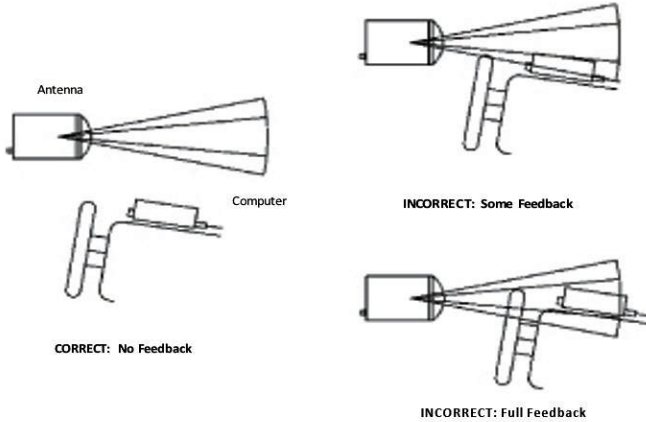

Figure 8.2.5a
Correcting feedback interference

8.2.6 Multi-Path Beam Cancellation

If multi-path beam cancellation occurs, the target motor vehicle speed sporadically blinks and reappears at semi-random intervals. This type of interference occurs when the radar loses track of a target motor vehicle, because the target is reflecting two or more signals, which are interfering with each other. The G3™ is immune to multi-path cancellation.

8.2.7 Patrol Harmonics

In all police radar, when a patrol motor vehicle passes a large, stationary object such as a road sign, building, or overpass, the return signal can briefly overload the processing circuitry. The G3™ detects this condition and will not display speeds which are generated by this overloading.



- Targets traveling at speeds which are close to the patrol speed can also mimic this condition and will be rejected. The target window will show a blank speed as the radar detects the harmonic. To process this type of target, simply increase or decrease your patrol speed by at least 3 km/h.

8.2.8 Radio Frequency Interference (RFI)

The system can inadvertently process radio energy as Doppler speeds, including that from police radios, airport radar, microwave transmission towers, CB radio transmitters, and AM/ FM transmission towers. For this type of interference to occur, the radar unit must be operating very close to the radio transmitter. The G3™ contains an RFI detection circuit that detects excess radio frequency energy. When stray radio frequency energy reaches an excessive level, the system displays the RFI message and stops processing and displaying speeds. The system resumes normal operation when the RFI condition no longer exists. At that time, any locked speeds will display again.

8.2.9 Shadowing

In Moving mode, the radar processes two speeds - patrol and target. The stronger of the two, the patrol speed, is created when the radar beam reflects from passing stationary objects, such as the pavement or terrain the motor vehicle is traveling on. However, in rare cases, some situations cause return signals to be larger than the reflection from the ground such as when the patrol motor vehicle is rapidly overtaking a slow-moving 18-wheeler. The radar may use the large return signal generated by the semi's trailer ignoring the ground return.

This results in an artificially low Patrol speed. The computer would then subtract this artificially low speed from the closing speed and assign a higher speed to the target.

The shadowing error is easy to recognize, because the radar patrol speed and the speedometer reading will vary significantly. The target speed in this instance also will vary considerably from your visual estimation.



- The G3™ usually recognizes and ignores shadowing. On the rare occasion that it appears, turning the antenna on and off usually quickly remedies shadowing.

8.2.10 Motor vehicle Ignition Interference

The G3™ has been designed to operate from the motor vehicle's cigarette lighter receptacle. However, some motor vehicles exhibit excessive alternator noise at the lighter receptacle. In these rare cases, the radar can exhibit erratic readings, especially when the motor vehicle's electrical system is operated under heavy load. Wiring an accessory outlet directly to the battery minimizes the effect.

If you suspect your motor vehicle's electrical system, contact Decatur Electronics' Customer Service Department for more information.

9.0 Field Tests

You shall do the following tests to verify the operation and accuracy of the G3™.

9.1 Operator-Requested Self Test

Pressing the TEST button initiates a comprehensive system self-test, which checks the numeric displays and runs a target and patrol speed simulation.

The G3™ will not power down during a self-test and checks the following:

DISPLAY TEST: Verifies that the digit segments and status LED lights are working correctly and that none of the pixels in the number segments are missing.

Successful LED test

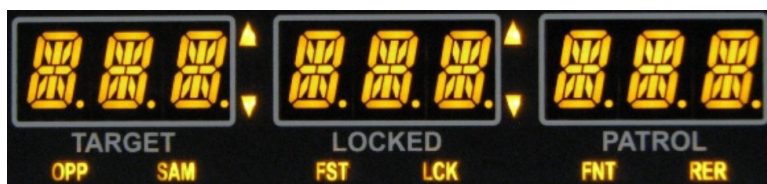

Figure 9.1a

All LED segments show for successful LED test

SPEED SIMULATION TEST: The G3™ verifies the speed accuracy using a series of synthesized Doppler frequencies corresponding to simulated speeds: A patrol speed sequence of 55, 85 and 100 km/h is processed first followed by a target test sequence of 40, 70, 100 and 130 km/h.

Patrol speed test sequence of 55, 85 and 100.



Figure 9.1b

PATROL test sequence

Target speed test sequence of 40, 70, 100 and 130.

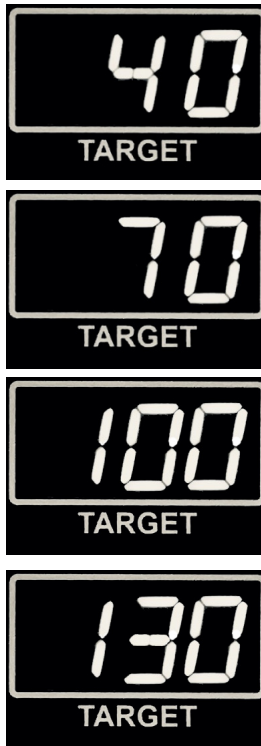

Figure 9.1c
TARGET test sequence

CIRCUITRY TEST: Checks the internal circuitry. If the unit passes all internal checks, the message TEST PASS displays in the display windows.



Figure 9.1d
Successful circuitry test

9.2 Road Test

After the radar unit passes the self-test you may want to conduct a road test during each shift to confirm that the patrol motor vehicle's speedometer matches the unit's patrol speed.

The road test verifies that the radar unit's patrol speed and the motor vehicle speedometer are within ± 1 display unit of each other. You need to conduct the road test on a level road.

1. Verify that the antenna is aimed correctly and parallel to the direction of travel.
2. Turn either the front or rear antenna on
3. Drive the patrol motor vehicle at a constant, legal speed to verify that the speedometer reading, and the patrol speed are within ± 1 display unit of each other.
4. If the difference is greater than ± 1 display unit, verify that the antenna is aligned correctly. If the antenna is aligned correctly, this reading can indicate a speedometer inaccuracy.



- An incorrectly aimed antenna will cause the radar unit's patrol speed to be lower than the speedometer's speed.

10.0. Care, Cleaning, and Storage

- Avoid spilling food, beverages, and other liquids and substances on the radar device.
- When you are not using or transporting the device, store it in its original packaging.
- To clean the radar device, dust it with a soft clean cloth, which is free of cleaning solutions.
- The G3™ can withstand temperature variations, however, only the antenna is weather resistant.
- Insert and remove the connectors by following the correct connect and disconnect procedures.

WARNING



- In case your unit has a blown fuse, please replace the fuse with another fuse rated at the same capacity.

DO NOT replace the fuse with a higher rated fuse since this may cause damage to the equipment and/or the motor vehicle.

Higher rated fuses will cause internal damage unit and will void the warranty.

In case the replacement fuse blows please send the unit in for the repairs.

11.0 Specifications

11.1 Mechanical

Display Unit

Dimensions	13.3 cm x 3.68 cm x 1.8 cm
Weight	0.11 kg

Computer Unit

Dimensions	13.33 cm x 3.68 cm x 6.35 cm
Weight	0.45 kg

Hand-Held Remote

Dimensions	11.58 cm x 4.00 cm x 2.84 cm
Weight	0.68 kg

Ka-Band Directional Antenna

Dimensions	7.16 cm x 8.9 cm
Weight	0.25 kg

11.2 Antenna

Ka-Band Directional

IACP type	VI
Nominal transmission frequency	35.500 GHz
Nominal horizontal beamwidth	12°
Polarization	Circular
Nominal microwave power output	15mW
Maximum aperture power density	< 2mW/cm ²

11.3 Environment

Ambient operating temperatures	-30°C to +70°C
Maximum humidity	90% R.H.at 37°C

11.4 Power Consumption

Supply voltage range	10.8 to 16.5VDC
Low voltage threshold	10.8VDC with visual indicator

Current draw (A) with 13.6VDC applied in various modes:

Standby (antenna OFF)	0.17 amperes
Ant. ON, no targets displayed	0.33 amperes
Ant. ON, 55 target displayed	0.36 amperes
Ant. ON, 20 target, 35 patrol	0.40 amperes
Ant. OFF, segment check 888 888 888	0.45 amperes
Ant. ON, segment check 888 888 888	0.60 amperes

11.5 Speed Range**Stationary Mode**

Target 19 km/h - 337 km/h

Moving Mode Opposite Direction

Patrol 8 km/h - 161 km/h

Target 19 km/h - Closure of 337 km/h

Moving Mode Same Direction

Patrol 32 km/h - 160 km/h

Slower Target 19 km/h - 120 km/h

Faster Target 40 km/h - 281 km/h

The Moving Mode Same Direction target speed is computed as follows:

when tracking a slower target $TS = PS - SS$

when tracking a faster target $TS = PS + SS$

where TS = Target Speed, PS = Patrol Speed and SS = Separation Speed

Separation Speed must be at least 4 km/h, but no greater than 75% of the patrol speed.

12.0 ISED Information

This device contains license-exempt transmitter(s)/receiver(s) that comply with Innovation, Science and Economic Development Canada's license-exempt RSS(s). Operation is subject to the following two conditions:

- (1) This device may not cause interference.
- (2) This device must accept any interference, including interference that may cause undesired operation of the device.

Caution: Any changes or modifications not expressly approved by the party responsible for compliance could void the user's authority to operate this equipment.

Industry Canada Regulatory Information CAN ICES-3 (A)/NMB-3 (A)

Cet appareil contient des émetteurs / récepteurs exemptés de licence conformes aux RSS (RSS) d'Innovation, Sciences et Développement économique Canada. Le fonctionnement est soumis aux deux conditions suivantes:

- (1) Cet appareil ne doit pas causer d'interférences.
- (2) Cet appareil doit accepter toutes les interférences, y compris celles susceptibles de provoquer un fonctionnement indésirable de l'appareil.

Attention: Tout changement ou modification non expressément approuvé par la partie responsable de la conformité peut annuler le droit de l'utilisateur de faire fonctionner cet appareil.

Avis d'Industrie Canada CAN ICES-3 (A)/NMB-3 (A)

13.0 Radiation Exposure Statement

This equipment complies with ISED radiation exposure limits set forth for an uncontrolled environment. This equipment should be installed and operated with minimum distance 20 cm between the radiator and your body.

Déclaration d'exposition aux radiations

Cet équipement est conforme aux limites d'exposition au rayonnement ISED établies pour un environnement non contrôlé. Cet équipement doit être installé et utilisé à une distance minimale de 20 cm entre le radiateur et votre corps.



Certificate of Conformity Certificat de conformité

IC:1270A-G3KAD	374712-9
Certification number / Numéro de Certification	Certification number / Numéro de Certificat
Issued to / Délivré à	Decatur Electronics 16990 Goldentop Road San Diego, Ca 92127
Specifications / Spécification	RSS-210, Issue 9
Hardware Version Number/ Numéro d'identification de la version du matériel	S795-45-0
Product Marketing Name/ Marque du produit	G3
Product description / Description du produit	Doppler radar speed sensor for law enforcement use
Firmware Version Identification Number/ Numéro d'identification de la version logiciel	NA
Host Marketing Name/ Nom de marque de l'hôte	NA
Type of equipment / Genre de matériel	Field Disturbance Sensor
Emissions information/ Information sur les émissions	Annex 1 / Annexe 1

Certification of equipment means only that the equipment has met the requirements of the above-noted specification. Licence applications, where applicable to use certified equipment, are acted on accordingly by the Innovation, Science and Economic Development Canada Licensing office and will depend on the existing radio environment, service and location of operation. This certificate is issued on condition that the holder complies and will continue to comply with the requirements and procedures issued by Innovation, Science and Economic Development Canada. The equipment for which this certificate is issued shall not be manufactured, imported, distributed, leased, offered for sale or sold unless the equipment complies with the applicable technical specifications and procedures issued by Innovation, Science and Economic Development Canada.

La certification du matériel signifie seulement que le matériel a satisfait aux exigences de la norme indiquée ci-dessus. Les demandes de licences nécessaires pour l'utilisation du matériel certifié sont traitées en conséquence par le bureau de délivrance d'innovation, Sciences et Développement économique Canada et dépendent des conditions radio ambiantes, du service et de l'emplacement d'exploitation. Le présent certificat est délivré à la condition que le titulaire satisfasse et continue de satisfaire aux exigences et aux procédures d'innovation, Sciences et Développement économique Canada. Le matériel à l'égard duquel le présent certificat est délivré ne doit pas être fabriqué, importé, distribué, loué, mis en vente ou vendu à moins d'être conforme aux procédures et aux spécifications techniques applicables publiées par l'innovation, Sciences et Développement économique Canada.

I hereby attest that the subject equipment was tested and found in compliance with the above-noted specification.
J'atteste, par la présente, que le matériel a fait l'objet d'essai et a été jugé conforme à la spécification ci-dessus.

Certified by / certifié par  Kevin Ma, Senior Technical Assessor	Date 9 / 8 / 2019 Day, Year / Month, Year, Week
---	---

Nemko North America, Inc
303 River Road, Ottawa, Ontario K1V1H2, CANADA
Tel: +1 613 337 5680 Fax: +1 613 337 5655

Page 1 of 2

ISED Certificate - Jul 2018





Annex 1 / Annexe 1

1270A-G3KAD
 Certification number / Numéro de Certification

374712
 Certificate number / Numéro de Certificat

Frequency / Fréquences (Mhz)	Field Strength / Intensité de Champ (dBuv/m@3m)	Emission designation / Genre d'émission
35482	117.69	257KN0N

Test laboratory /
 Laboratoire d'essai

Nemko USA Inc
 2210 Faraday Ave, Suite 150
 San Diego Ca. 92008, USA
 +1 760-444-3409

Laboratory number /
 Numéro de laboratoire

2040B-3

Additional information/
 Renseignements
 supplémentaires

N/A

Antenna information /
 Renseignements sur l'antenne

21dB integral



14. Frequently Asked Questions (FAQ)

Q. *My radar device will not power up. What should I do?*

- A. Make sure the radar device is plugged into the power source and that the power source has power. Also, check to see if the LED light on the power plug is on and that the fuse in the power plug is working. If the unit still does not power up, contact Decatur Electronics.

Q. *My radar device has poor range. How can I remedy this?*

- A. Make sure the range control is adjusted properly and verify that no obstructions are in front of the antenna. If the antenna still has poor range, increase the range (sensitivity) level. If this problem continues, contact Decatur Electronics.

Q. *Does the G3™ interface with in-car video systems?*

- A. Decatur's traffic safety radar devices will interface with various in-car video systems using its SERIAL port. Please call your in-car video supplier to see if their device works with your Decatur radar device.

Q. *What upgrades are available now for my G3™?*

- A. Contact your Decatur Sales Representative for upgrade information.

Q. *SYSTEM ERR appears in the display windows?*

- A. If your unit has a system error, turn the unit off and on. If it still says SYSTEM ERR, contact your Decatur Sales Representative.

15.0 Service

15.1 Warranty

THREE-YEAR RADAR WARRANTY

Decatur Electronics guarantees the G3™ to be free from defects in workmanship and material and to operate within specifications for a period of three years. During this period, Decatur Electronics will repair or replace, at its option, any component, found to be defective, without cost to the owner providing you return the unit to a Decatur authorized service provider.

The full warranty on parts and workmanship does not include normal wear and tear, crushing, dropping, fire, impact, immersion, damage from attempted repair, modifications by unauthorized service agents, or improper voltage and fusing (including removal of the power plug.)

THREE-YEAR WARRANTY EXCEPTION

If you purchased the radar unit under a special buying program, such as a state purchase contract, etc., the above warranty may not apply. Please refer to the buying program contract for the appropriate warranty terms or contact Decatur Electronics.

15.2 Service Return Procedure

If you have questions, want a quick problem diagnosis, or need to return your unit or a component from your unit:

- Call Decatur Electronics by phoning 800.428.4315 and ask to speak with a Customer Service Representative.
- Explain to the Customer Service Representative the problem you are experiencing.
- Based on the information that you provide; the Customer Service Representative may be able to assist you or you may need to be referred to one of our Service Providers.

The customer is responsible for paying for shipping to the Service Provider. On warranty items Decatur Electronics will pay return shipping (ground freight) from the Service Provider to the customer. Please note that will be an additional charge for shipping express or next day air.

If you are referred to a Service Provider and your product is under warranty then once your product has been received, the Service Provider will investigate the problem. Once they have diagnosed the problem, they will repair the product and return it to you.

If you are referred to a Service Provider and your unit is not under warranty, then we recommend that you discuss the problem you are experiencing with the Service Provider and determine if an estimate is needed. Once your product has been received, the Service Provider will investigate the problem and you will be sent an estimate of cost, prior to any repair work being performed. After receiving the estimate, you can choose from the following options:

1. Approve the estimate and proceed with repair.
2. Decline the estimate and pay an estimate fee and return shipping.
3. Discuss other options with the Service Provider. If your product is under warranty it will automatically be repaired and sent back to you.

16.0 How to Order Additional Products

You can order upgrades (when available) to the G3™ from Decatur Electronics as well as different antenna cable lengths and mounting brackets. Contact the Decatur Sales Representative..

Antennas (for both front and rear mounts)

Ka-band Directional antenna S795-45-0

Antenna cables

3-ft. (91.44 cm) antenna cable P769-79503R

7-ft. (2.13 meters) antenna cable P769-79507R

10-ft. (3.04 meters) antenna cable P769-79510R

14-ft. (4.26 meters) antenna cable P769-79514R

25-ft. (7.62) antenna cable P769-79525R

Brackets

Glue-on windshield mounting bracket S773-235A-0

Deck mount (mounts on flat surface) S758-34-0

Detachable display bracket S758-51-0

Display

Display separation kit S769-116-0

Appendix A: Communications Port

A RS232 communications port is located on the rear panel of the computer unit. The pinout of the DB-9 serial connector is:

Pin 1: +12 VDC auxiliary power out.

Pin 2: RS232 transmit out of G3™ radar.

Pin 3: RS232 receive into the G3™ radar.

Pin 4: VIP (Vehicle Interface Protocol GEN 2) input into G3™ radar.

Pin 5: Signal/power ground.

Pin 6: No connection.

Pin 7: Speedometer pulse input.

Pin 8: No connection.

Pin 9: No connection.

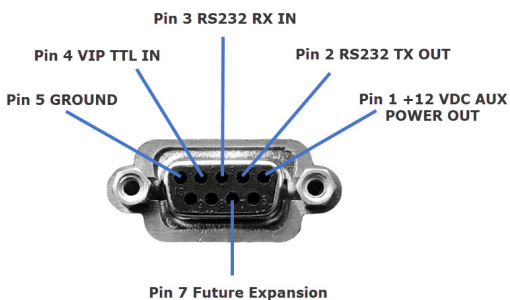

Figure A
Serial port pin out

Appendix B: Communications Port - serial protocols.

G3™ COM X serial outputs selections:

COMX setting Output

0	No output
1	Diagnostic output
2	Linear spectrum output
3	Future expansion
4	Future expansion
5	Future expansion
6	Future expansion
7	G3™ standard output
8	COPS (Common Output Protocol) Please contact your local sales or service agent for protocol description.
9	Power dB spectrum output

G3™ Standard Output:

The standard serial communication has the following characteristics (8N1) and is transmit only:

- One (1) start bit
- Eight (8) data bits
- No parity
- One (1) stop bit
- Transmission at 1200 baud

The G3™ transmits data as ASCII symbols in the following digit sequence:

<i>Target</i>	<i>Patrol</i>
[hundreds][tens][ones]	[hundreds][tens][ones]<CR>

(<CR> = ASCII decimal value 13)

The G3™ sends the data in this sequence when the TARGET or PATROL speed display changes, or when the MODE or antenna selection changes. During the test sequence the target and patrol speeds transmit, but the display segment check data do not.

When you press the LOCK button, the G3™ transmits the following digital sequence: [hundreds][tens][ones]<CR> (<CR> = ASCII decimal value 13)

Appendix C: Menu Features

The menu feature allows the operator to fine tune some of the settings of the radar. To activate the menu feature, press MENU button.

Pressing OPTN steps through the menu items and the antenna buttons change the settings. Pressing the MENU button again exits the menu feature and saves the settings.

<u>Feature</u>	<u>Setting</u>	<u>Function</u>
SENS	1-5	Range setting (sensitivity setting)
SQUELCH	ON, OFF	Toggles squelch setting on or off
DIM	AUTO, 1-8	Automatic or manual control of the display LED brightness
BEEP	ON,OFF	Beep - Beeps when button is pushed on the hand remote. Default is ON
COMX	0- 5	Serial Port Communications Protocol - Selects protocol for interfacing to MDT, signs, etc.
HARMONIC	ON, OFF	If ON, radar will show "H" in center target window during a harmonic event. If set to OFF, radar will blank a target speed during a harmonic event.
VIP	AUTO, MAN	VIP Auto or Manual mode
HWY CTY	ALL, CTY, HWY	Choose CTY mode to help eliminate combining during low speed patrol use. Choose HWY mode to help eliminate patrol shadowing during higher speed patrol use. Choose ALL setting for best performance in both modes.

USER NOTES



www.DecaturElectronics.com

16990 Goldentop Road, San Diego, CA, 92127, USA
800.428.4315

Over 60 Years of Doppler Radar Experience